

AQUADECK®
POOLCOVERS

Price List
2024

CLOSE _____
TO BE PERFECT

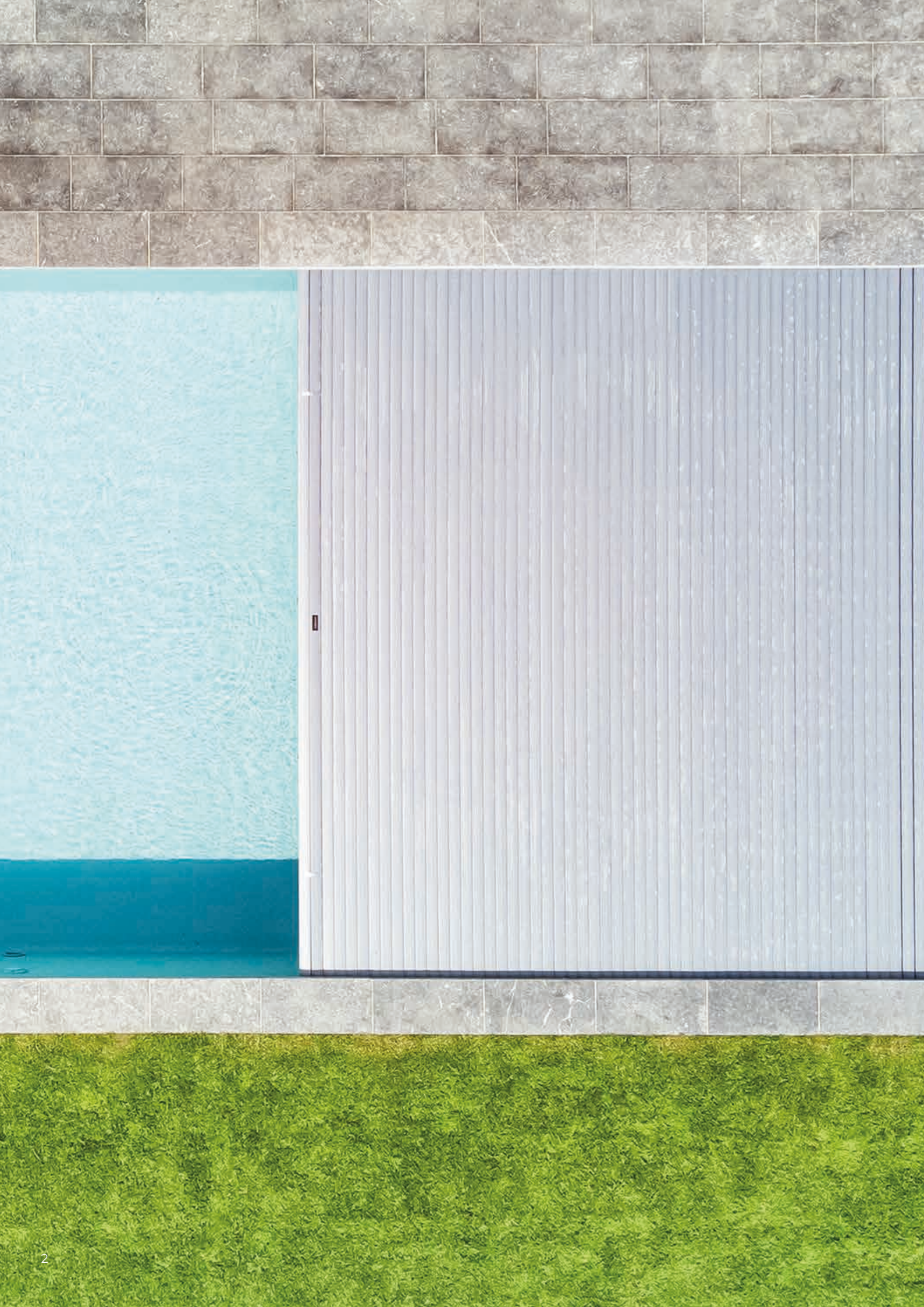





Contents

Aquadeck®, about us	4
Pool covers	10
PVC Slats	14
PC Slats	16
Additional adjustments to the slats	20
Built-in and surface-mount options	22
Tubular motor for submerged applications	24
Assembly kits for tubular motor	26
External motor for pit applications	32
Tubular motor for top-mount applications Deluxe	33
External motor for top-mount applications Basic	34
Structure finishing	36
Accessories	44
Motors and accessories	46
Aquadeck® OrderTool	48

Aquadeck® , about us

A swimming pool exudes luxury, quality time and relaxation, and it invites people to play or exercise... Each pool component should contribute to this. At Aquadeck, we have regarded covers as crucial in this regard for 25 years. Indeed, a cover is essential at both the start and the end of the day. And not just for safely opening and closing the pool. It minimises water loss and energy consumption, and it can even heat the pool. With our slats, the cover also perfectly matches any garden. Functionality and design go hand in hand with us, and you can see that in every detail. When you choose Aquadeck®, you choose a state-of-the-art product where we are always looking for further perfection.

Aquadeck® Close ... to be perfect!

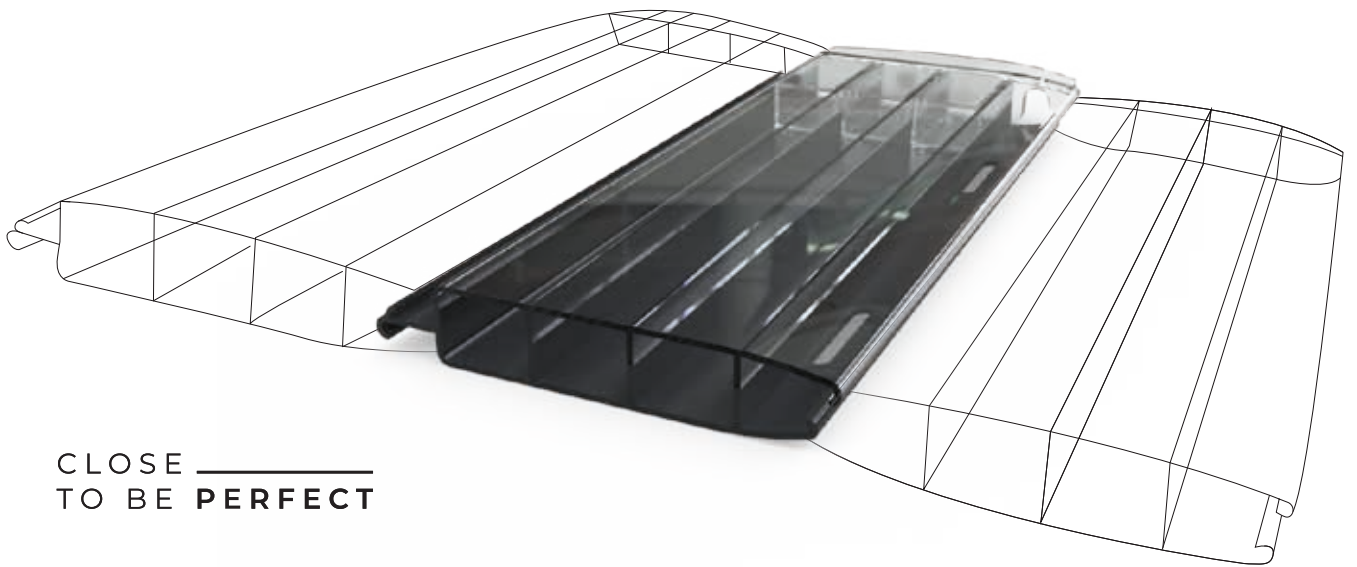

CLOSE _____
TO BE PERFECT



Aquadeck®, about us

Aquadeck, a leading manufacturer for 25 years

Aquadeck® is passionate about pools and covers. Precisely because of this ambition, for 25 years we have been a leading manufacturer of automatic cover systems. Aquadeck® is based in Budel, The Netherlands. We produce top-quality slatted pool covers with care and craftsmanship. We work with the best and nicest materials, develop the smartest structures, and use the safest and most durable components. This is driven by a high level of knowledge and years of experience, which make the difference. Innovation has already brought us much but, in our view, it is never-ending: there is always room for even better, smarter or more beautiful things. We are only satisfied when you are satisfied.

Our partner, the pool builder

We are very close to our pool builders. They work with our products every day, from advice to implementation and maintenance. They are crucial, and only by and with them is it possible to implement projects where the pool owner also gets what they dreamed of: a cover that perfectly meets all requirements and wishes and enriches the garden, both functionally and visually.

Our partners' support starts with ease of installation through our smart solutions. If help is still needed, there is always our customer-focused service and support. Here as well, Aquadeck® strives for perfection. And if necessary, we visit the site ourselves to help our partners with our own Aquadeck® Service Department.

Our intuitive Aquadeck® OrderTool reduces the margin of error to a minimum, right from the time of order, and our catalogue creates clarity in choices, installation options, finishing options and accessories.

Aquadeck® naturally also offers its partners a comprehensive training programme in which we explain all aspects in detail. As a partner, but also as a customer, you also always enjoy short delivery times and continuous quality thanks to our fully automated production. These are all core values that are embedded in our policies and make us who we are. This is the only way we can optimally serve our partners now and in the future, which is what we always strive for.



- Comprehensive training programme in Budel or on site
- Short delivery times
- Optimal customer-oriented support
- Configure any cover with the Aquadeck® OrderTool
- Constant high quality
- Aquadeck® Service

Our ambition

goes far beyond simply making products

We want to show every day that we have everything right. For 25 years, our partners have been satisfied because we help them be successful and have fun with our products. That gives us pleasure, it is what drives us, and it leads to good performance and results. We enjoy it when our partners and customers tell us the result is even more beautiful and better than they had hoped. That makes us happy! We also think customers should expect that. An automatic cover forms a significant part of the total cost of the pool. Then everything has to be right, from the brochure to trouble-free cover operation and a long, trouble-free life.

Aquadeck is fully dedicated to this. A team of specialists is ready to help you with your wishes and questions. We will interpret each specific situation correctly and complete it with a cover that is right in all regards.





Our company

Our team consists of 25 specialists. Our aim is to increasingly automate production through continuous investment. This allows us to produce efficiently and smartly while guaranteeing quality. It is also why we give a full 5 year warranty on all our products. The team is largely made up of people in advisory and support roles. A flat organisation ensures short lines of communication, making us agile so that customers are helped quickly.

Working together with you

Being successful is nice. Sharing success together is even better. We like to be aware of what is going on with our partners, what they are working on and how they are doing. If we know what is happening, we can help even better to share many moments of success. They learn from us, and we very much learn from them. Theory and design on the drawing board is the basis. Achieving this in practice is something else, which is why we like to seek dialogue in order to learn from each other and keep improving. Because there is always room for improvement.



Our team

which we are so proud of

We can only make good, beautiful products and help customers if each individual understands what matters. The intrinsic will to do things right is the basis. Interest and eagerness to learn make the difference. Aquadeck tries to encourage employee involvement with in-house training, by visiting projects together, and by taking over each other's tasks on a regular basis. We work on our team and work pleasure every day, because that is the basis of a good and fine company.

Are you a new customer? If you are not yet especially familiar with our products, reach out to Sales Support. They can assist you with your first project to ensure it goes well. Do you need extensive training? That's also possible in consultation with Sales Support.



SALES ADMIN

Our Sales Admin department is always ready to answer your questions about current orders. They are also the right place for questions about transport or invoices.

info@aquadeck.nl

Ans Clement

SALES SUPPORT

Sales Support gives you advice on special projects. They can also help you move forward when confronted with a problem or when something doesn't work.

salesupport@aquadeck.nl

Joery Schellens

Theo van Lindt

Tom Goossens

Rob van Dalen

PURCHASING

Our Purchasing department ensures optimal procurement for our products. Here as well we opt for partnerships with our suppliers.

inkoop@aquadeck.nl

Martijn van der Zwet

Michael Golsteijn



PRODUCTION

Our professionals. They make all the covers and structures, with everything tailored to your projects.

Patrick, Marck, Jordi, Mischa, Adam,
Martin, Joep

LOGISTICS

Our Logistics staff look after all logistics activities within Aquadeck and to customers.

Bart, Ruud, Stefan

MANAGEMENT

Roy Peeters
General Manager

Ramon Koevoets
Operational Manager

Angela Velings
Sales Manager

Dennis Velings
Product Manager

Aquadeck® Swimming pool covers

Why Aquadeck? The benefits at a glance

An automatic pool cover serves multiple purposes: saving water, reducing energy consumption, increasing safety, minimising pollution, and even free heating. We want to achieve all this for every type of pool, and the cover must always function smoothly, be easy to operate and look great. All aspects are equally important to us in this regard. All this leads to concrete benefits which we are happy to list for you:

✦ **Anti-algae**

A swimming pool is prone to algae formation. This is also true with a cover. Together with a partner, Aquadeck has developed a smart solution to prevent algae formation. Our slats incorporate slots to ensure that the chlorinated pool water always flushes the coupling chamber clean when the cover is opened or closed. As a result, our anti-algae concept ensures self-cleaning slats that remain free of algae.

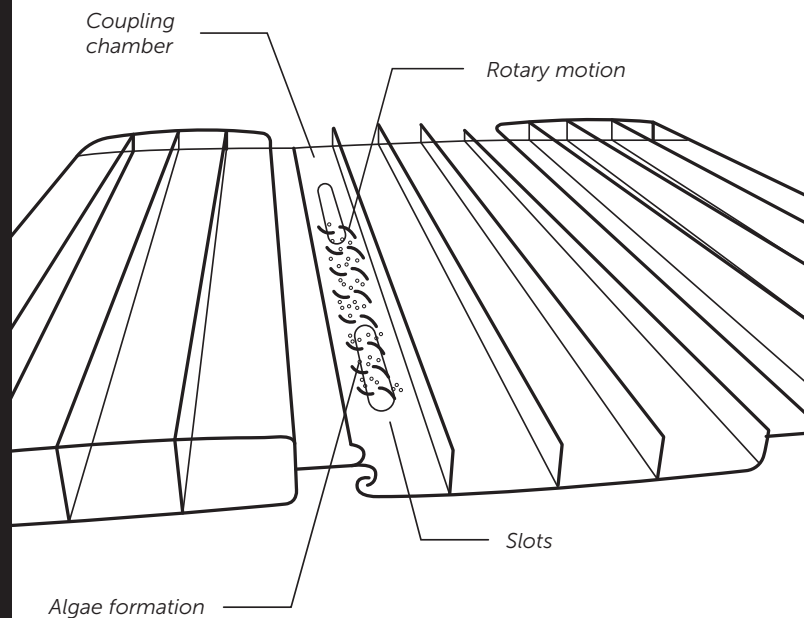

🚚 **Short delivery times**

Even though each cover is custom-made with a range of choices, we make each cover within 3 weeks and often even faster. This is possible thanks to our automated production and our intentionally high stock levels for all components. This is all because we realise that the cover is crucial for the pool to be energy efficient in operation, but also because it allows our partners to complete and deliver projects

Continuous quality assurance

Fully automated production of custom winding tubes and slats not only ensures efficient and fast production, it also prevents human errors. Sizes are always right, holes are drilled perfectly and slats are made 100% watertight, with the same parameters every time. This is how we ensure quality with every cover.

Price/quality

Effective production and automation allow us to deliver the best products at fair prices. High quality avoids unnecessary margin waste and other costs. And all this allows for generous warranty terms.

OrderTool

The OrderTool we developed ourselves is there for our partners and for us. It allows customers to quickly configure each cover, including the price. Use it as a quotation tool and later turn it into an order with a single mouse click. Thanks to the built-in algorithms, it also prevents errors, minimising wrong orders.



Installation parts for any type of pool

Where others opt for universal fittings, we have special fittings for each type of pool. This way, the customer gets exactly what is wanted for the specific situation. This also ensures easy and user-friendly assembly.



Double sealing

Our hightech machine ultrasonically welds and seals with silicone to ensure 100% watertightness. In the process, even the dosing of the silicone is controlled for volume and pressure in the slat chambers. The slats are also blown through with dry air, minimising condensation.

Tri-extrusion

The slat ageing process is highly sensitive to sunlight-induced wear. Aquadeck slats are extruded using tri-extrusion. This means that a strong UV protection layer is applied on top of the slat where it is needed to provide protection. With many other slats, less protection is added and/or is mixed with the PVC or PC granules, so most of it does not end up where it should. Aquadeck slats therefore stay beautiful much longer and do not yellow.



Warranty

Because of the confidence in our components and our production, we provide a 5-year warranty on everything if it turns out that something breaks that has nothing to do with incorrect installation or incorrect use of the cover.

Safety

Safety in and around your pool is paramount. Aquadeck® slats have high buoyancy due to the design of the air chambers. It may not be seen as a safety cover, but it does increase safety. Our robust key switch can fully prevent unwanted opening and closing of the cover.



Design

Close to be perfect! A closed Aquadeck® cover fits perfectly with your pool and looks wonderful. Aquadeck® creates an uncluttered and luxurious design. For every pool there is a matching Aquadeck® cover. The slats harmonise perfectly with your overall pool and garden aesthetics and are available in a variety of colours. We also offer a choice of two different materials: polyvinyl chloride (PVC) as standard, or polycarbonate (PC) for even higher quality and longer life.



Aquadeck® PVC Slats

PVC slats are more economical than PC. PVC is a durable material, but is less resistant to hail impact.

The maximum slat width is 7m. For slats wider than 6m, please contact Aquadeck.

- Five year warranty.
- Economical
- Ideal for indoor pools



Slats PVC White

Round up the pool length and width to 0.5 metres

Pool width	2m	2,5m	3m	3,5m	4m
Price per m ^l	€185	€220	€255	€290	€325
Item number	3009050440	3009050441	3009050442	3009050443	3009050444

Pool width	4,5m	5m	5,5m	6m
Price per m ^l	€360	€395	€430	€465
Item number	3009050445	3009050446	3009050447	3009050448

Calculation example: pool size (width x length) 3.90 x 11.00 m = item number 3009050444 (4m) x 11

Stairs options White PVC

3009050740	Roman end stairs PVC White	€616
3009050748	Trapezium end stairs PVC White	€616
3009050756	Rectangular end stairs PVC White	€616



For surcharge adjustment of slats for round corners, skimmer guide and skimmer cut-out see page 20

Slats PVC Grey

Round up the pool length and width to 0.5 metres

Pool width	2m	2,5m	3m	3,5m	4m
Price per m ^l	€185	€220	€255	€290	€325
Item number	3009050429	3009050430	3009050431	3009050432	3009050433

Pool width	4,5m	5m	5,5m	6m
Price per m ^l	€360	€395	€430	€465
Item number	3009050434	3009050435	3009050436	3009050437

Calculation example: pool size (width x length) 5.40 x 12.40 m = item number 3009050436 (5.5m) x 12.50

Stairs options Grey PVC

3009050739	Roman end stairs PVC Grey	€616
3009050747	Trapezium end stairs PVC Grey	€616
3009050755	Rectangular end stairs PVC Grey	€616



For surcharge adjustment of slats for round corners, skimmer guide and skimmer cut-out see page 20

Aquadeck® PC Slats

Polycarbonate slats are more impact resistant and last longer. Transparent slats are often used for indoor pools. All other PC slats have a solar effect because they are not fully opaque, but slightly transparent. As a result, solar energy is converted into heat for free heating of the pool water. The Aquadeck PC slats are resistant to hail impact and have a hail certification/hallmark.

The maximum slat width is 7m. For slats wider than 6m, please contact Aquadeck.

- Five year warranty
- Hailproof
- High impact resistance
- Longer lifespan
- With anti-algae
- More heat resistant

Slats PC Transparent

Round up the pool length and width to 0.5 metres

Pool width	2m	2,5m	3m	3,5m	4m
Price per m ^l	€315	€385	€450	€510	€580
Item number	3009050418	3009050419	3009050420	3009050421	3009050422

Pool width	4,5m	5m	5,5m	6m
Price per m ^l	€645	€710	€775	€840
Item number	3009050423	3009050424	3009050425	3009050426

Calculation example: pool size (width x length) 2.40 x 8.80 m = item number 3009050419 (2.5m) x 9.00

Stairs options Transparent PC

3009050734	Roman end stairs PC Transparent	€1.009
3009050742	Trapezium end stairs PC Transparent	€1.009
3009050750	Rectangular end stairs PC Transparent	€1.009

For surcharge adjustment of slats for round corners, skimmer guide and skimmer cut-out see page 20



Transparent

NEW IN 2024

Fitted with black caps

Slats PC Solar

Round up the pool length and width to 0.5 metres

Pool width	2m	2,5m	3m	3,5m	4m
Price per m ^l	€315	€385	€450	€510	€580
Item number	3009050374	3009050375	3009050376	3009050377	3009050378

Pool width	4,5m	5m	5,5m	6m
Price per m ^l	€645	€710	€775	€840
Item number	3009050379	3009050380	3009050381	3009050382

Calculation example: pool size (width x length) 3.10 x 8.00 m = item number 3009050377 (3.5m) x 8.00

Stairs options Solar PC

3009050733	Roman end stairs PC Solar	€1.009
3009050741	Trapezium end stairs PC Solar	€1.009
3009050749	Rectangular end stairs PC Solar	€1.009

For surcharge adjustment of slats for round corners, skimmer guide and skimmer cut-out see page 20

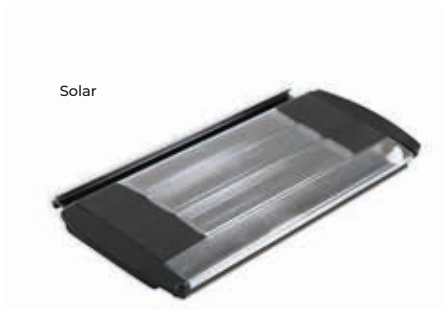

Solar

NEW IN 2024

Fitted with smoke caps

Slats PC Graphite Solar

Note: Due to their dark colour, Graphite Solar PC slats are more sensitive to thermal influences. With large temperature differences between the air and water, this can take the form of temporary deformation. These slats are also more susceptible to scratches and scale and require a bit more maintenance.

Round up the pool length and width to 0.5 metres

Pool width	2m	2,5m	3m	3,5m	4m
Price per m ^l	€340	€410	€480	€550	€620
Item number	3009050407	3009050408	3009050409	3009050410	3009050411

Pool width	4,5m	5m	5,5m	6m
Price per m ^l	€690	€765	€835	€910
Item number	3009050412	3009050413	3009050414	3009050415

Calculation example: pool size (width x length) 5,20 x 11,90 m = item number 3009050414 (5,5m) x 12,00

Stairs options Graphite Solar PC

3009050735	Roman end stairs PC Graphite solar	€1.099
3009050743	Trapezium end stairs PC Graphite solar	€1.099
3009050751	Rectangular end stairs PC Graphite solar	€1.099

Graphite Solar



For surcharge adjustment of slats for round corners, skimmer guide and skimmer cut-out see page 20

Slats PC Platinum Solar

Round up the pool length and width to 0.5 metres

Pool width	2m	2,5m	3m	3,5m	4m
Price per m ^l	€340	€410	€480	€550	€620
Item number	3009050396	3009050397	3009050398	3009050399	3009050400

Pool width	4,5m	5m	5,5m	6m
Price per m ^l	€690	€765	€835	€910
Item number	3009050401	3009050402	3009050403	3009050404

Calculation example: pool size (width x length) 5,95 x 12,75 m = item number 3009050404 (6,0m) x 13,00

Stairs options Platinum Solar PC

3009050736	Roman end stairs PC Platinum solar	€1.099
3009050744	Trapezium end stairs PC Platinum solar	€1.099
3009050752	Rectangular end stairs PC Platinum solar	€1.099

Platinum Solar



For surcharge adjustment of slats for round corners, skimmer guide and skimmer cut-out see page 20

Slats PC Metallic Solar

Round up the pool length and width to 0.5 metres

Pool width	2m	2,5m	3m	3,5m	4m
Price per m ^l	€340	€410	€480	€550	€620
Item number	3009050385	3009050386	3009050387	3009050388	3009050389

Pool width	4,5m	5m	5,5m	6m
Price per m ^l	€690	€765	€835	€910
Item number	3009050390	3009050391	3009050392	3009050393

Calculation example: pool size (width x length) 1.95 x 8.60 m = item number 3009050385 (2.0m) x 9.00

Stairs options Metallic Solar PC

3009050737	Roman end stairs PC Metallic solar	€1.099
3009050745	Trapezium end stairs PC Metallic solar	€1.099
3009050753	Rectangular end stairs PC Metallic solar	€1.099

For surcharge adjustment of slats for round corners, skimmer guide and skimmer cut-out see page 20

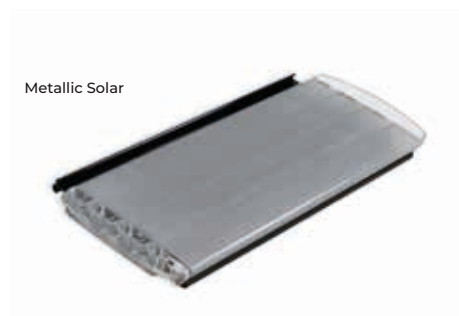

NEW IN 2024

Slats PC Cobalt Solar

Round up the pool length and width to 0.5 metres

Pool width	2m	2,5m	3m	3,5m	4m
Price per m ^l	€340	€410	€480	€550	€620
Item number	3009050787	3009050788	3009050789	3009050790	3009050791

Pool width	4,5m	5m	5,5m	6m
Price per m ^l	€690	€765	€835	€910
Item number	3009050792	3009050793	3009050794	3009050795

Calculation example: pool size (width x length) 2.90 x 10.00 m = item number 3009050789 (3.0m) x 10.00

Stairs options Cobalt Solar PC

3009050738	Roman end stairs PC Cobalt solar	€1.099
3009050746	Trapezium end stairs PC Cobalt solar	€1.099
3009050754	Rectangular end stairs PC Cobalt solar	€1.099

For surcharge adjustment of slats for round corners, skimmer guide and skimmer cut-out see page 20



Additional adjustments to the slats

Shark fins for skimmers and rectangular stairs

An attractive rounding to guide the slats with skimmers on the long side of the pool and with rectangular stairs

3009050757	Shark fin on both sides of the slats	€26,00
3009050758	Shark fin on the left side of the slats	€22,00
3009050759	Shark fin on the right side of the slats	€22,00

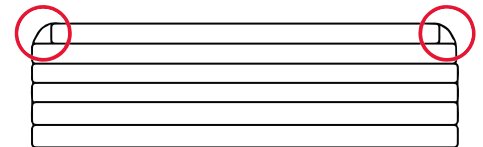

Cascading for skimmers and rectangular stairs

Staggered shortening of the first three slats for skimmers on the long side of the pool and for rectangular steps

3009050760	1st 3 slats cascading on both sides	€18,00
3009050761	1st 3 slats cascading on left-hand side	€18,00
3009050762	1st 3 slats cascading on right-hand side	€18,00

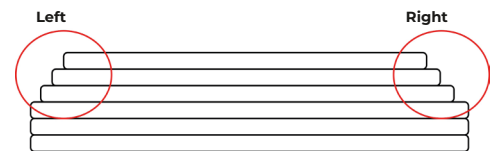

Rounded edges in the pool

Staggered slat shortening.

3009050763	Rounded edges at the front of the pool R1 and R2	€19,00
3009050764	Rounded edges at the front and back of the pool R1 through R4	€25,00



Skimmer/Inlet cut-out

If skimmers and/or inlets are present at the end of the pool where the tube is also located, cut-outs can be provided in the slats so that the skimmers/inlets are not blocked by the slats when the cover is closed.

3009050765	1x Skimmer/inlet cut-out	€62,00
3009050766	2x Skimmer/inlet cut-out	€67,00
3009050767	3x Skimmer/inlet cut-out	€82,00

3009050768	4x Skimmer/inlet cut-out	€ 97,00
3009050769	5x Skimmer/inlet cut-out	€ 112,00
3009050770	6x Skimmer/inlet cut-out	€ 127,00

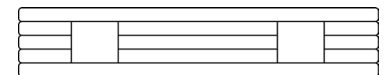

Cascading over the length of the pool

3009050039	Slat cascading per running metre	€121	p/m1
------------	----------------------------------	------	------

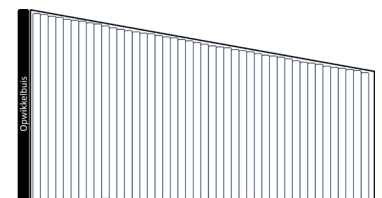

Cut-out for pool ladder

3009050343	Cut-out for pool ladder	€426
------------	-------------------------	------

For unusually shaped pools and stairs, please consult our Sales department for a quotation

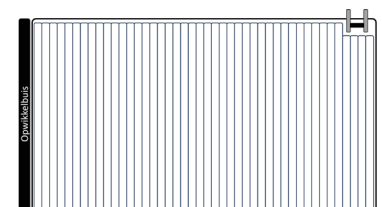



Aquadeck® built-in and surface-mount options

Aquadeck® supplies automatic cover systems for any type of swimming pool, with various built-in and surface-mount options. With new pools, you normally choose to conceal the roll in a recess behind the pool or to place the winding tube inside the pool where a wall plate or wall allows you to conceal the roll invisibly in various ways. If this is not easily possible, an above-ground solution can also be chosen. All Aquadeck systems are smartly made for great ease of installation and operation. Here we list the various built-in/surface-mount options:



Corner cover

Corner cover

The corner cover allows the roll to be hidden at the bottom in pools that do not have a recess in or behind the pool. This makes it ideal for existing pools that are retrofitted with an automatic cover. For enhanced safety, the housing of the corner cover clicks firmly into a pre-installed stainless steel structure. A cut-out in the corner cover prevents dirt accumulation.

Top-mount

With the top-mount system, any pool can be fitted with a slatted cover. Nothing needs to be modified or built into the pool itself. This is the simplest solution for existing pools. The surface-mount system can be fitted with a protective cover.

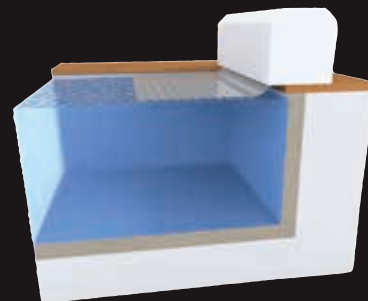

Top-mount with cover



Inserted beam

Inserted beam

The inserted beam allows the roll to be installed in a recess behind a wall. A tile can then be placed on the wall and the inserted beam for a super sleek finish, and it serves as a bench at the same time.

Lounger

The lounger solution is similar to the inserted beam solution, with the difference that no tile is provided on the wall and insert rail, but instead a sleek white PVC plate that is clicked onto a fitted stainless steel structure. Aquadeck supplies the complete stainless steel structure together with the finishing sheet. The PVC plate also serves as a bench or lounge area.



Lounger



Protective plate

Protective wall plate

With the protective wall plate, the roll is hidden in a recess behind the pool, with Aquadeck supplying the PVC protective wall plate to size. A cut-out prevents dirt from accumulating. The PVC protective wall plate can optionally be covered with PVC liner to harmonise with the pool walls and bottom.

Fixed floor plate

If the pool has a recess in the bottom, the roll under the pool can be protected with a fixed bottom plate.



Fixed floor plate

Tubular motor for submerged applications

An attractive built-in solution

A tubular motor provides a very nice solution. The motor is mounted and hidden in the tube from the cover. The system can be operated electronically.

Construction with 250 Nm tubular motor

Includes:

Tubular motor 24V, 250 Nm fitted with 10m cable	Electronic control 220/24V	Key switch surface-mount	
Stainless steel 316 winding tube Ø 139mm	Electronic end adjustment	Threaded socket 40x1"	
	Set of ribbons 1500mm	Casting kit for tubular motor **	

Construction with built-in 250 Nm tubular motor, supplied as standard with 10m cable length (excluding mounting kit)
Round up to 0.5 metres.

2m	2,5m	3m	3,5m	4m	4,5m	5m	5,5m	6m
€5.076	€5.192	€5.308	€5.424	€5.542	€5.658	€5.773	€5.890	€6.006
3009050001	3009050002	3009050003	3009050004	3009050005	3009050006	3009050007	3009050008	3009050009

Surcharge for longer cable length

15m	20m
€224	€353
3009050091	3009050292



Construction with 500 Nm tubular motor

Includes:

Tubular motor 24V, 500 Nm fitted with 15m cable	Electronic control 220/24V	Key switch surface-mount	
Stainless steel 316 winding tube Ø 206 mm	Electronic end adjustment	Threaded socket 40x1"	
	Set of ribbons 1500mm	Casting kit for tubular motor **	

Construction with built-in 500 Nm tubular motor, supplied as standard with 15m cable length (excluding mounting kit)
Round up to 0.5 metres.

2m	2,5m	3m	3,5m	4m	4,5m	5m	5,5m	6m
€8.690	€8.889	€9.089	€9.289	€9.490	€9.689	€9.886	€10.088	€10.289
3009050304	3009050305	3009050306	3009050307	3009050308	3009050309	3009050310	3009050311	3009050312

Longer cable length not possible

** The warranty will be voided if the cable is not cast on using the casting kit provided!
All systems must be easy to dismantle for the exchange of tubular motors.

Complete assembly kits for construction 250Nm tubular motor

Wall duct for concrete and masonry pools

Applicable for pools with already finished walls. Wall ducts require drilling through the wall. This can still be done even if the liner/tiles is/are already in place. Suitable for all types of pools.

✔ Concrete and masonry pools already equipped with liner or tiles



3009050085	Complete wall duct kit with 320mm tube	€375	p/kit
3009050699	Complete wall duct kit with 360mm tube	€375	p/kit
3009050602	Complete wall duct kit without 320/360mm tube	€375	p/kit

Wall duct for PE/PP swimming pools



3009050182	Complete wall duct kit with 100mm tube for PE/PP pools	€375	p/kit
3009050183	Complete wall duct kit without 100mm tube for PE/PP pools	€375	p/kit

Wall duct for fiberglass and vinylester pools

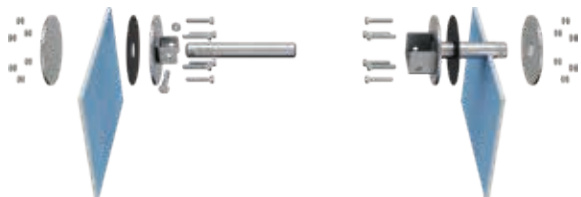

3009050184	Complete wall duct kit 100mm for fiberglass/vinylester pools	€375	p/kit
------------	--	------	-------

Wall duct for stainless steel pools



3009050116	Complete wall duct kit 100mm for stainless steel pools	€375	p/kit
------------	--	------	-------

Embedded parts for concrete, masonry and polystyrene pools

To be used in new-build swimming pools where the embedded parts can be integrated into the concrete. Liner/tiles to be installed afterwards.



3009050086	Complete embedded parts kit with 320mm tube	€546	p/kit
3009050701	Complete embedded parts kit with 360mm tube	€546	p/kit

Embedded part, motor side only, for concrete and masonry pools

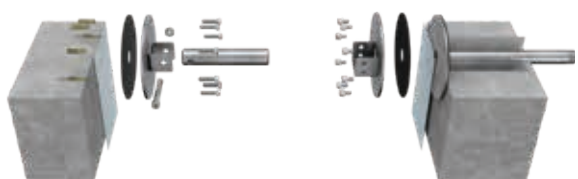

3009050600	Complete kit single-side embedded part with 320mm tube, other side directly on the wall	€546	p/kit
------------	---	------	-------

Pre-assembly parts for concrete and masonry pools

Applicable for pools with existing concrete walls. Liner to be installed afterwards.



3009050084	Complete kit of pre-assembly parts with 320mm tube	€546	p/kit
3009050700	Complete kit of pre-assembly parts with 360mm tube	€546	p/kit

Cable tray for concrete and masonry pools

For use with existing pools already finished with liner/tiles. Drilling into the wall is not necessary. The motor cable is routed in a stainless steel cable tray.

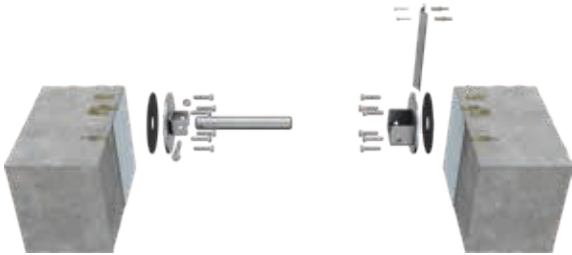

3009050083	Complete cable tray kit with length 1250mm	€375	p/kit
------------	--	------	-------

✔ Concrete and masonry pools already equipped with liner or tiles

Suspension plates for all types of pools

For use with existing pools already finished with liner/tiles. Drilling into the wall is not necessary. The stainless steel suspension plates are installed between the top of the pool wall and the coping stones. For this purpose, concrete must be provided at the location of the suspension plates. The motor cable is routed in an integrated stainless steel cable tray on the suspension plate.

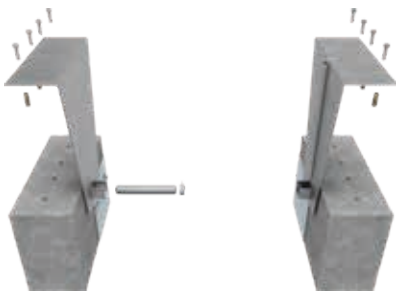

3009050055	Complete kit with suspension plates 500mm	€865	p/kit
------------	---	------	-------

Loose embedded/pre-assembly/finishing parts for construction 250Nm tubular motor

Our advice is to always order complete kits of assembly parts (page 26-28). If you wish to keep separate stocks of pre-assembly/finishing parts in the build process, you will find the relevant individual items here.

To be used in new-build swimming pools where the embedded parts can be integrated into the concrete. Liner/tiles to be installed afterwards.



3009050076	Set embedded parts with 320mm tube	€171	p/kit
------------	------------------------------------	------	-------

- ✔ Concrete and masonry pools **not yet** lined with foil
- ✔ Polystyrene pools **not** yet covered with liner
- ✘ **Excluding** finishing kit (item no. 3009050114)



3009050077	Pre-assembly parts with 320mm tube	€171	p/kit
------------	------------------------------------	------	-------

- ✔ Concrete and masonry pools **not yet** lined with foil
- ✘ **Excluding** finishing kit (item no. 3009050114):

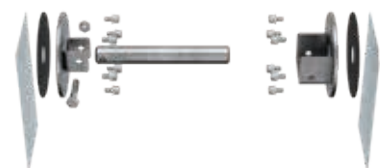

3009050114	Finishing set for embedded parts, pre-assembly parts and pre-assembly plates	€375	p/kit
------------	--	------	-------

- ✔ Concrete, masonry and polystyrene pools equipped with embedded parts (3009050076)
- ✔ Concrete, masonry and polystyrene pools fitted with pre-assembly parts (3009050077)
- ✔ Concrete, masonry and polystyrene pools fitted with pre-assembly plates (3009050088 + 3009050583)

Complete assembly kits for construction 500Nm tubular motor

Wall duct for concrete and masonry pools

To be used with pools with previously finished walls. Wall ducts require drilling through the wall. This can still be done even if the liner/tiles is/are already in place. Suitable for all types of pools.



3009050702	Complete wall duct kit with 320mm tube (500 Nm)	€644	p/kit
------------	---	------	-------

Wall duct for PE/PP swimming pools



3009050729	Complete wall duct kit with 100mm tube for PE/PP pools (500 Nm)	€690	p/kit
------------	---	------	-------

Embedded parts for concrete, masonry and polystyrene pools

To be used in new-build swimming pools where the embedded parts can be integrated into the concrete. Liner/tiles to be installed afterwards.



3009050711	Complete kit of embedded parts with 320mm tube (500 Nm)	€940	p/kit
------------	---	------	-------

Embedded part, motor side only, for concrete and masonry pools

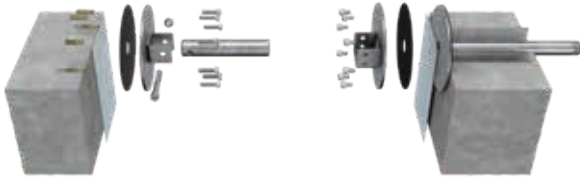

3009050713	Complete kit single-side embedded part with 320mm tube, other side directly on the wall (500 Nm)	€940	p/kit
------------	--	------	-------

Cable tray for concrete and masonry pools

For use with existing pools already finished with liner/tiles. Drilling into the wall is not necessary. The motor cable is routed in a stainless steel cable tray.

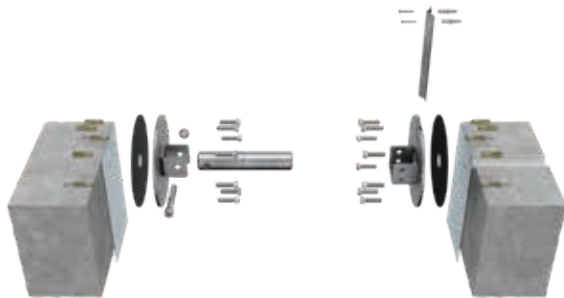

3009050712	Complete cable tray kit with length 1250mm (500 Nm)	€644	p/kit
------------	---	------	-------



External motor for pit applications

A recessed solution with external motor

Another recessed option is working with an external motor. The motor drives the tube and is placed in a watertight pit next to the pool.

Construction with external motor

Includes:

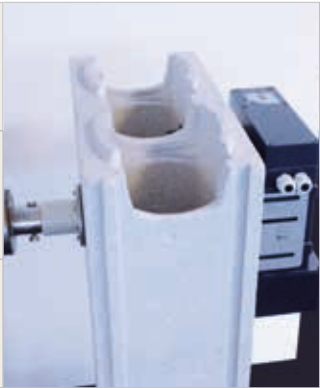
External drive motor 24V	Electronic control 220/24V	Key switch surface-mount	
Stainless steel 316 winding tube Ø 139mm	Electronic end adjustment	Wall duct incl. drive shaft	
	Set of straps 1500mm	Casting kit for external motor	

Construction with external motor (including all fixing materials)
Round up to 0.5 metres.

2m	2,5m	3m	3,5m	4m	4,5m	5m	5,5m	6m
€3.912	€4.039	€4.164	€4.290	€4.417	€4.543	€4.668	€4.792	€4.918
3009050010	3009050011	3009050012	3009050013	3009050014	3009050015	3009050016	3009050017	3009050018



Tubular motor for top-mount applications

Top-mount Deluxe

For outdoor application, only suitable for polycarbonate slats. For indoor application, all colours possible.
Maximum 15 metre pool length possible.

Construction with tubular motor (splash-proof) ***

Includes:

Splashproof tubular motor 24V fitted with 10m cable ***	Electronic control 220/24V	Key switch surface-mount	
Winding tube	Threaded socket 40x1"	2x Design end stands	
	Set of straps 1500mm	Casting kit for tubular motor **	

Construction with built-in tubular motor supplied as standard with 10m cable length (including all fixing materials)
Round up to 0.5 metres.

2m	2,5m	3m	3,5m	4m	4,5m	5m	5,5m	6m
€4.402	€4.473	€4.520	€4.603	€4.604	€4.746	€4.746	€4.840	€5.124
3009050327	3009050328	3009050329	3009050330	3009050331	3009050332	3009050333	3009050334	3009050335

Suitable up to a maximum pool length of 15m

** The warranty will be voided if the cable is not cast on using the casting kit provided!

All systems must be easy to dismantle for the exchange of tubular motors.

*** The surface-mount Deluxe comes with a splash-proof tube motor.

This tubular motor is not suitable for use under water.



External motor for top-mount applications

Top-mount Basic

The construction is placed on top of the pool and can be finished with an aluminium self-supporting protective cover in white. The top of the protective cover can optionally be equipped with a bench finish or personal design.

Top-mount basic with bench cover

Includes:

External drive motor 24V	Electronic control 220/24V	Key switch surface-mount	
Stainless steel 316 winding tube Ø139mm	Electronic end adjustment	aluminium frame with bench and side plates 540mm	
	Set of straps 1500mm	Self-supporting aluminium protective cover	

Surface-mount winding structure with self-supporting protective cover (including all fixing materials)
Protective cover size: 555x550mm. Powder-coated, colour white (RAL 9010).

Round up to 0.5 metres.

2m	2,5m	3m	3,5m	4m	4,5m	5m	5,5m	6m
€6.131	€6.200	€6.264	€6.574	€6.640	€6.952	€7.021	€7.645	€8.250
3009050019	3009050020	3009050021	3009050022	3009050023	3009050024	3009050025	3009050026	3009050027

Optional:

3009050115	Polyester bench plate - Plate length = 1900 mm	€470	p/piece
3009050344	Surcharge raised end stands (2 pieces) 540mm for overflow pools	€291	p/piece



** Note: Higher brackets are required for overflow pools. Please mention this when ordering.



Top-mount Basic without bench cover

Includes:

External drive motor 24V	Electronic control 220/24V	Key switch surface-mount	
Stainless steel 316 winding tube Ø139mm	Electronic end adjustment	Aluminium frame without bench	
	Set of straps 1500mm		

Round up to 0.5 metres.

2m	2,5m	3m	3,5m	4m	4,5m	5m	5,5m	6m
€4.284	€4.351	€4.418	€4.486	€4.554	€4.622	€4.691	€5.250	€5.550
3009050028	3009050029	3009050030	3009050031	3009050032	3009050033	3009050034	3009050035	3009050036

Optional:

3009100408	Loose polyester side plate 540mm	€295	p/piece
3009050344	Surcharge raised end stands (2 pieces) 540mm for overflow pools	€291	p/piece



** Note: Higher brackets are required for overflow pools. Please mention this when ordering.

Construction finishing

Various finishes and options are available based on the installation choice.

Corner cover PVC white

Corner cover construction suitable up to a maximum pool length of 12m (excluding mounting kit).

The maximum width of one corner cover plate is 2100/2600mm. Depending on the pool width, the corner cover parts are divided and supplied in sections for ease of handling.

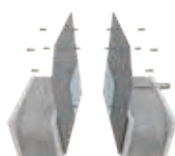

Round up to 0.5 metres.

2m	2,5m	3m	3,5m	4m	4,5m	5m	5,5m	6m
€1.620	€2.150	€2.580	€2.860	€2.925	€3.780	€3.840	€3.960	€4.070
3009050473	3009050474	3009050475	3009050476	3009050477	3009050478	3009050479	3009050480	3009050481

Complete assembly kits for corner cover structure

3009050625	Complete assembly kit for corner cover type Standard. To be mounted directly on the wall.	€210	p/kit
3009050624	Complete assembly kit for corner cover type Cable tray. To be mounted directly on the wall.	€210	p/kit

Pre-assembly plates for corner cover structure (excluding finishing parts)

3009050088	Kit of pre-assembly plates LEFT for corner cover	€721	p/kit
3009050583	Kit of pre-assembly plates RIGHT for corner cover	€721	p/kit

Finishing parts for the above pre-assembly plates

3009050623	Finishing parts for corner cover with pre-assembly plates	€210	p/kit
------------	---	------	-------

NOTE

Did you know that you can cover all PVC finishing plates with PVC liner? That way, the finishing structure perfectly matches the pool and forms a beautiful whole.

Corner cover LARGE PVC white

Corner cover construction suitable up to a maximum pool length of 17m (excluding mounting kit). The maximum width of one cover plate is 1500mm. Depending on the pool width, the corner cover parts are divided and supplied in sections for ease of handling.

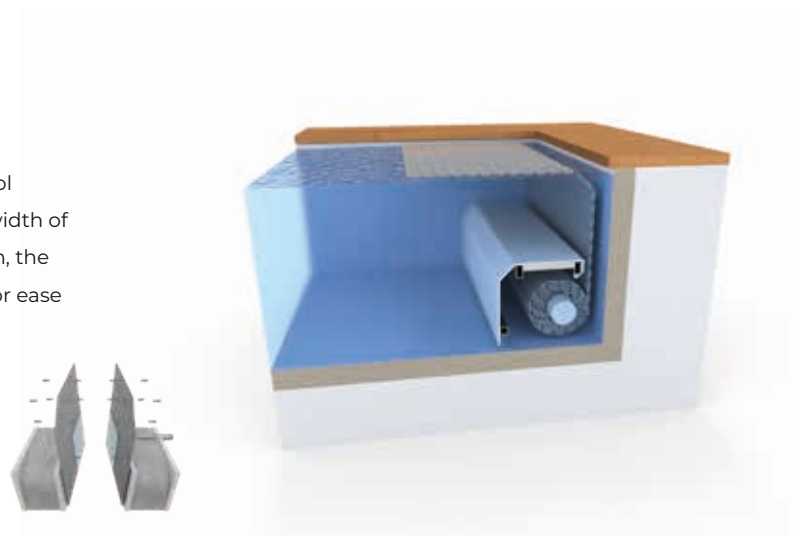

Round up to 0.5 metres.

2m	2,5m	3m	3,5m	4m	4,5m	5m	5,5m	6m
€2.850	€3.190	€3.810	€4.620	€4.710	€5.860	€5.940	€6.190	€7.240
3009050484	3009050485	3009050486	3009050487	3009050488	3009050489	3009050490	3009050491	3009050492

Complete assembly kits for LARGE corner cover construction

3009050730	Complete assembly kit for LARGE corner cover type Standard. To be mounted directly on the wall.	€228	p/kit
3009050731	Complete assembly kit for LARGE corner cover type Cable tray. To be mounted directly on the wall.	€228	p/kit

Pre-assembly plates for LARGE corner cover construction (excluding finishing parts)

3009050697	Kit of pre-assembly plates LEFT for LARGE corner cover	€1.060	p/kit
3009050319	Kit of pre-assembly plates RIGHT for LARGE corner cover	€1.060	p/kit

Finishing parts for the above LARGE pre-assembly plates

3009050732	Finishing parts for LARGE corner cover with pre-assembly plates	€228	p/kit
------------	---	------	-------

Protective plate PVC white 750mm high

Protective plate mounted on a stainless steel 316L construction, incl. suspension bracket (excluding mounting kit). Dimensions 1 plate: max. 750x2100mm. Depending on the pool width, the protective plates are divided and also supplied in sections for ease of handling.

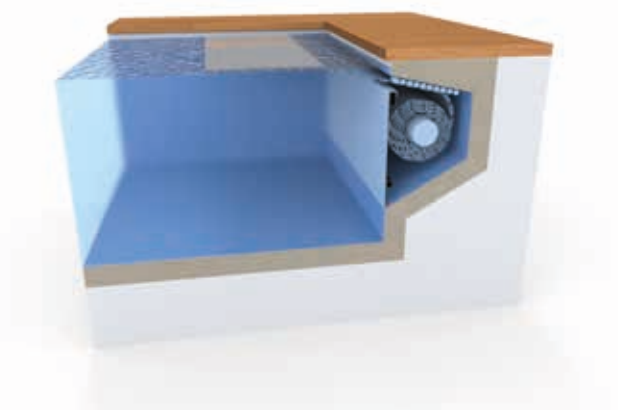

Round up to 0.5 metres.

2m	2,5m	3m	3,5m	4m	4,5m	5m	5,5m*	6m*
€990	€1.580	€1.590	€1.730	€1.810	€2.400	€2.490	€2.560	€2.640
3009050495	3009050496	3009050497	3009050498	3009050499	3009050500	3009050501	3009050502	3009050503

* Note: For pool widths greater than 5m, we recommend using a reinforced frame (see item number 3009050137).

Complete assembly kits for protective plate 750mm

3009050630	Complete assembly kit for protective plate 750 mm type Standard. To be mounted directly on the wall.	€210	p/kit
3009050632 <small>(3009100812 + 3009050359)</small>	Complete assembly kit for protective plate 750 mm type Prefabricated parts (including finishing parts)	€475	p/kit

Pre-assembly parts for protective plate 750 mm

3009100812	Loose kit of pre-assembly parts for 750mm protective plate (excluding finishing parts)	€265	p/kit
------------	--	------	-------

Finishing parts for the above pre-assembly parts

3009050359	Loose kit of finishing parts for protective plate 750mm	€210	p/kit
------------	---	------	-------

Reinforced frame for protective plate (recommended for pools wider than 5m)

3009050137	Surcharge for reinforced frame for protective plate	€722	p/piece
------------	---	------	---------

Protective plate PVC white 1400mm high

Protective plate mounted on a stainless steel 316L construction, incl. suspension bracket (excluding mounting kit). Size of 1 plate: max. 1400x1000mm. Depending on the pool width, the protective plates are divided and supplied in parts for ease of handling.



Round up to 0.5 metres.

2m	2,5m	3m	3,5m	4m	4,5m	5m	5,5m*	6m*
€1.495	€2.040	€2.140	€2.720	€2.820	€3.360	€3.460	€4.010	€4.110
3009050506	3009050507	3009050508	3009050509	3009050510	3009050511	3009050512	3009050513	3009050514

* Note: For pool widths greater than 5m, we recommend using a reinforced frame (see item number 3009050137).

Complete assembly kits for protective plate 1400mm

3009050631	Complete assembly kit for protective plate 1400 mm type Standard. To be mounted directly on the wall.	€310	p/kit
3009050633 <small>(3009100843 + 3009050360)</small>	Complete assembly kit for protective plate 1400 mm type Prefabricated parts (including finishing parts)	€693	p/kit

Pre-assembly parts for protective plate 1400mm

3009100843	Loose kit of pre-assembly parts for 1400mm protective plate (excluding finishing parts)	€383	p/kit
------------	---	------	-------

Finishing parts for the above pre-assembly parts

3009050360	Loose kit of finishing parts for protective plate 1400mm	€310	p/kit
------------	--	------	-------

Reinforced frame for protective plate (recommended for pools wider than 5m)

3009050137	Surcharge for reinforced frame for protective plate	€722	p/piece
------------	---	------	---------

NOTE

Did you know that you can cover all PVC finishing plates with PVC liner? That way, the finishing structure perfectly matches the pool and forms a beautiful whole.

Lounger PVC white

Lounger construction, extendible to a maximum pool length of 12m (excluding assembly kit). Size: 1 lounger plate is 850x2100/2600mm. Depending on the pool width, the plates are divided and delivered in sections for ease of handling.

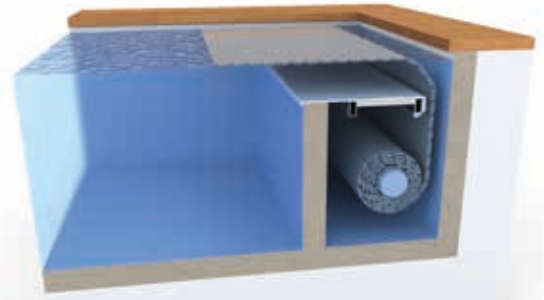

Round up to 0.5 metres.

2m	2,5m	3m	3,5m	4m	4,5m	5m	5,5m	6m
€1.655	€2.140	€2.575	€2.905	€2.945	€3.640	€3.675	€3.830	€3.865
3009050557	3009050558	3009050559	3009050560	3009050561	3009050562	3009050563	3009050564	3009050565



NOTE

Niche width including wall should be 850mm.
Ask for the lounger installation instructions

Complete assembly kits for Lounger construction

3009050724	Complete assembly kit for standard lounger To be mounted directly on the wall	€180	p/kit
------------	--	------	-------

Pre-assembly plates for lounger construction

3009050088	Set of pre-assembly plates LEFT for lounger	€721	p/kit
3009050583	Set of pre-assembly plates RIGHT for lounger	€721	p/kit

Finishing parts for the above pre-assembly plates

3009050646	Finishing parts for lounger with pre-assembly plates	€180	p/kit
------------	--	------	-------

Fixed floor plate PVC white

Floor plate construction, pit width max. 700mm (including all fasteners). For pool widths greater than 3m, the floor plate consists of two parts.

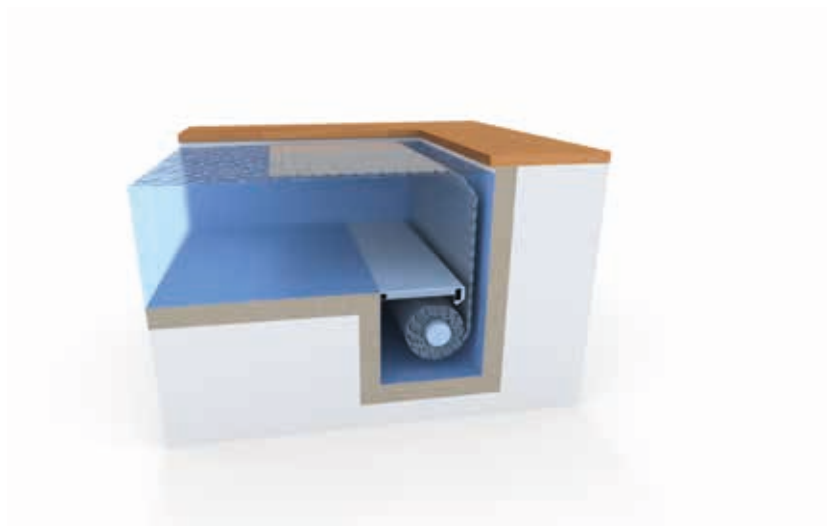

Round up to 0.5 metres.

2m	2,5m	3m	3,5m	4m	4,5m	5m	5,5m	6m
€1.745	€1.825	€1.910	€2.540	€2.665	€2.750	€2.850	€2.940	€3.126
3009050517	3009050518	3009050519	3009050520	3009050521	3009050522	3009050523	3009050524	3009050525

NOTE

Did you know that you can cover all PVC finishing plates with PVC liner? That way, the finishing structure perfectly matches the pool and forms a beautiful whole.

Fixed floor plate LARGE PVC white

Floor plate construction LARGE, pit width max. 1000mm (including all fasteners). For pool widths greater than 3m, the floor plate consists of two parts.

Round up to 0.5 metres.

2m	2,5m	3m	3,5m	4m	4,5m	5m	5,5m	6m
€2.355	€2.445	€2.540	€3.430	€3.510	€3.790	€4.360	€4.395	€4.525
3009050528	3009050529	3009050530	3009050531	3009050532	3009050533	3009050534	3009050535	3009050536

Supported beam stainless steel 316

Supported beam stainless steel 316 - 100x100mm (including fixing material)

Round up to 0.5 metres.

2m	2,5m	3m	3,5m	4m	4,5m	5m	5,5m	6m
€818	€1.022,50	€1.227	€1.431,50	€1.636	€1.840,50	€2.045	€2.249,50	€2.454
3009050539	3009050540	3009050541	3009050542	3009050543	3009050544	3009050545	3009050546	3009050547

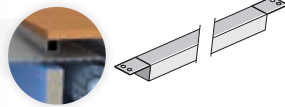

Note: There is a risk of sagging with rail lengths greater than 5 metres
Finishing only possible with timber

Supported beam stainless steel 304

Supported beam stainless steel 304 - 100x100mm (including fixing material)

Round up to 0.5 metres.

2m	2,5m	3m	3,5m	4m	4,5m	5m	5,5m	6m
€588	€735	€882	€1.029	€1.176	€1.323	€1.470	€1.617	€1.764
3009050548	3009050549	3009050550	3009050551	3009050552	3009050553	3009050554	3009050555	3009050556

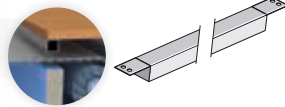

Note: There is a risk of sagging with rail lengths greater than 5 metres
Finishing only possible with timber

Inserted beam stainless steel 316

Inserted beam stainless steel 316 - 100x100mm (excluding mounting kit)

Round up to 0.5 metres.

2m	2,5m	3m	3,5m	4m	4,5m	5m	5,5m	6m
€558	€763	€967	€1.172	€1.376	€1.581	€1.785	€1.990	€2.194
3009050348	3009050349	3009050350	3009050351	3009050352	3009050353	3009050354	3009050355	3009050356



Note: There is a risk of sagging with rail lengths greater than 5 metres

Inserted beam stainless steel 304

Inserted beam stainless steel 304 - 100x100mm (excluding mounting kit)

Round up to 0.5 metres.

2m	2,5m	3m	3,5m	4m	4,5m	5m	5,5m	6m
€328	€475	€622	€769	€916	€1.063	€1.210	€1.357	€1.504
3009050365	3009050366	3009050367	3009050368	3009050369	3009050370	3009050371	3009050372	3009050373



Note: There is a risk of sagging with rail lengths greater than 5 metres

Complete assembly kits for inserted beam stainless steel 316/304

3009050638	Complete assembly kit standard inserted beam. To be mounted directly on the wall.	€260	p/kit
3009050641	Complete assembly kit inserted beam with embedded parts (incl. finishing kit)	€438	p/kit
3009050640	Complete inserted beam mounting kit with pre-assembly parts (incl. finishing kit)	€438	p/kit

Accessoires



Adjustable stainless steel cantilever bracket

3009050050	SS adjustable cantilever bracket max 700mm	€374/pc
------------	--	---------

Recommended installation spacing: cantilever bracket per 700mm
** Only timber finishing possible.*



Guide rollers for guiding the slats

3009050045	PC guide roller 700mm - 18 wheels	€92,00/pc
3009050118	PC guide roller 1000mm - 26 wheels	€114/pc
3009050117	SS guide roller 700mm - 18 wheels	€92,00/pc
3009050046	SS guide roller 1000mm - 26 wheels	€114/pc
3009050721	Set of mounting brackets for guide roller	€36,90/pc

Recommended installation spacing: 1 guide roll per 700mm

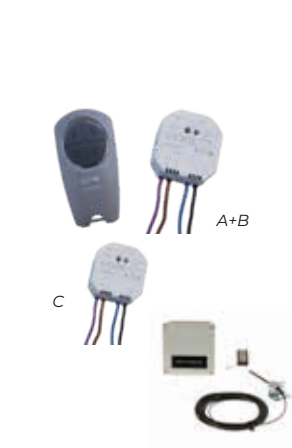

Remote control

3009050052	Remote control	A+B	€395/set
3009050053	Extra receiver (p.e. lighting)	C	€230/pc
3009100810	Remote control with 4 programmable relays for covers with 3 freely programmable relays.		€639/set



Key switch

3009100543	Surface-mount key switch incl. spare key (standard)	€212/pc
3009100548	Recessed key switch incl. spare key	€245/pc



Drift off prevention pendulum kit for overflow pools

3009100811	Drift off prevention pendulum kit for overflow pools stainless steel 316 (8 x pendulum, 2 x stopper)	€99,00/set
------------	--	------------

One set is for pools up to 10 metres.



Set of straps

3009100913	Set of 8 straps 1500mm black	€59,00/set
3009100914	Set of 8 straps 2500mm black	€69,00/set
3009100915	Set of 8 straps 3000mm black	€79,00/set

Transport/packaging



3009050363	Standard packaging 3,5m	€179/pc
3009050316	Standard packaging 4,5m	€205/pc
3009050317	Standard packaging 5,5m	€245/pc
3009050318	Standard packaging 6,2m	€310/pc
3009050655	Export packaging 3,5m	€360/pc
3009050656	Export packaging 4,5m	€390/pc
3009050657	Export packaging 5,5m	€570/pc
3009050658	Export packaging 6,2m	€640/pc
3009050095	Carton roll 4m - max 24 slats	€87,00/pc
3009050096	Carton roll 5m - max 24 slats	€98,00/pc
3009050097	Carton roll 6m - max 24 slats	€112/pc



Deck box

3009050040	Terrace pot. Safest solution for storing the cable seal kit and extra cable	€197/pc
------------	---	---------

Motors and accessories



Aquamot 250

3009100454	Shaft hole Ø 30mm Supply voltage 24V DC Power 250 Nm. 3.5 rpm Programmable end stop	€2.150/pc
------------	---	-----------



Aqua - Junior 120

3009100455	Shaft hole Ø 30mm Supply voltage 24V DC Power 120 Nm. 5 rpm Programmable end stop	€1.540/pc
3009050221	Mounting bracketset for Aqua-junior/Aquamot	€73,00/pc
3009100492	Sensor for Aquamat 120/250 & Aqua-junior	€149/pc



Aqua ECB

3009100469	Electronic control Incl. transformer 230/24V for aqua-junior, aquamat 250 and aqua tubular motor 250 Nm	€925/pc
------------	--	---------

NEW IN Q1 2024



Aqua DCB Digital Control Box

3009050784	Electronic control with Bluetooth module. With the Aquadeck Poolcover app, the cover can be programmed, the direction of rotation changed and the speed can be set. Can also be used with other brands of tubular motors.	€1.120/pc
------------	--	-----------

NEW IN Q3 2024



Surfaced LED control panel

3009050785	LED touchscreen, surface-mount, splash-proof. To be used in combination with the Aqua DCB Control Box. Equipped with security code.	On request
------------	---	------------

Aqua tubular motor PVC 250 Nm

Supply voltage 24DC
 Power 250Nm
 3,5 rpm
 Programmable end stop



3009050070	Aqua tubular motor PVC 250Nm 10 metre cable	€2.860/pc
3009050780	Aqua tubular motor PVC 250Nm 15 meter cable	€3.090/pc
3009050781	Aqua tubular motor PVC 250Nm 20 meter cable	€3.250/pc

What wire sizes should be used when extending Aquadeck motor cables?

Motorsupply 24V

<25 metre extension with 2x 2.5mm²

<50 metre extension with 2x 4mm²

Sensor contacts

<25 metre extension with 6x 1mm²

<50 metre extension with 6x 2.5mm²



Casting kit for tubular motor

3009050054	Casting kit for tubular motor	€68,00/pc
------------	-------------------------------	-----------



Stainless steel chain transmission in motor pit

3009050047	SS chain transmission in motor pit kit	€1.045/pc
------------	--	-----------



External motor to tubular motor conversion kit

3009050089	Conversion kit external to tubular motor	€390/pc
------------	--	---------

If no Aqua-CTS/ECB is fitted on site, it should be ordered additionally.

Aquadeck® OrderTool

Configure your cover online

As an Aquadeck® partner, you enjoy the benefits of our Aquadeck® OrderTool. In a few clicks, you can configure a new cover. Just log in, select sizes and options, and automatically get a detailed quotation. This way, we avoid mistakes and together increase customer satisfaction! The Aquadeck® OrderTool allows you to make a detailed price calculation, place an order, and view your order history. The benefits of the Aquadeck OrderTool at a glance:

- Available 24/7
- Manage quotations easily and quickly
- Convert quotations to orders; copy or modify items
- Download and print both net and gross quotations

No login yet? Visit www.aquadeck.nl and request your login. We will be happy to assist you further!

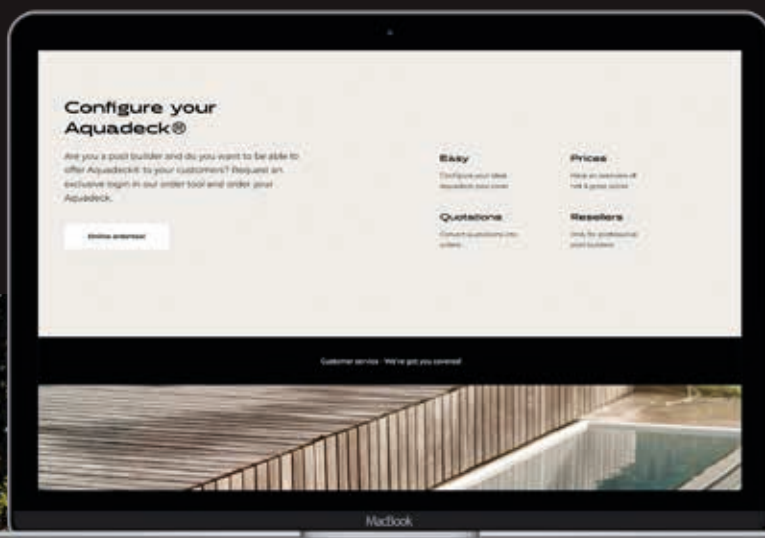

Aquadeck® OrderTool

Getting started

The Aquadeck® OrderTool is there especially and only for you as a professional pool builder. The tool is your fastest and most efficient path towards a new project. We are happy to help you on your way.

If you have any questions, do not hesitate to call or email us at Sales or Technical Support.

STEP 1

Visit www.aquadeck.nl/OrderTool or download the app from the App Store or Play Store

STEP 2

Log in

Log in with your personal user name and password.

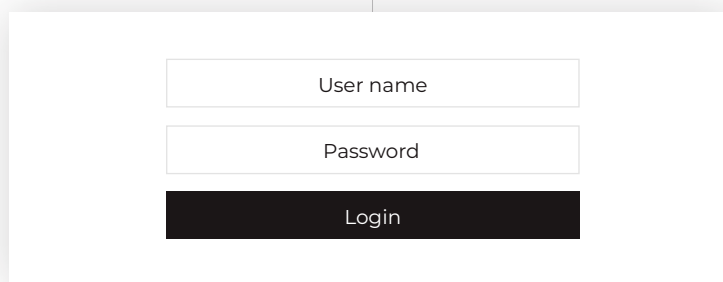



User name

Password

Login

STEP 3

Interface

- Creating a new quotation 
- Change your personal details 
- Logout 

STEP 4

Quotations & orders

You have two folders: quotations and placed orders





Quotations

Orders

STEP 5

OrderTool features

After creating a quotation, you have the following options:

- Download quotation 
- Place quotation in order 
- Duplicate quotation 
- Modify quotation 
- Delete quotation 



AQUADECK®
POOLCOVERS

AQUADECK, CLOSE TO BE PERFECT!

De la Minestraat 2
6021 PJ Budel
The Netherlands

T +31 (0)495 430 317
E info@aquadeck.nl
W www.aquadeck.nl

